

Installation and Operation Manual

All In One Heat Pump Water Heater

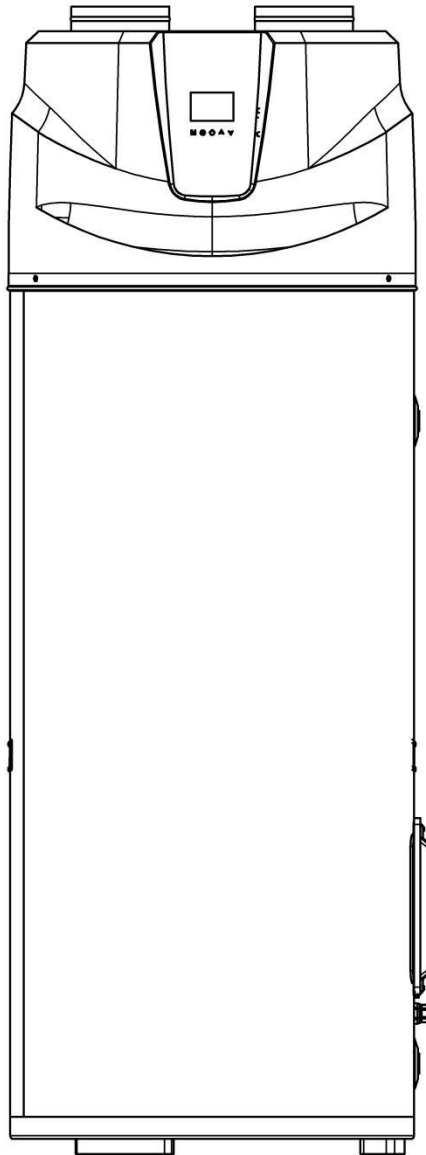

This all in one heat pump is suitable for indoor environments.

If the power cord is damaged, it must be replaced by a qualified person in order to avoid danger.

Table of Contents

1. Product description

- 1.1 Product features
- 1.2 Working mode
- 1.3 Product appearance
- 1.4 Working mode
- 1.5 Product appearance

2. Storage, transportation and handling

- 2.1 Storage and transportation
- 2.2 Handling

3. Installation

- 3.1 Placement space requirements
 - 3.1.1 Installation location and space requirements
 - 3.1.2 Electrical requirements
- 3.2 Installation method
 - 3.2.1 Water pipe connection
 - 3.2.2 Condensate drain pipe
 - 3.2.3 PTR valve installation
 - 3.2.4 Thermal expansion tank (not provided)
 - 3.2.5 Temperature limiting device (not provided)
 - 3.2.6 Pressure limiting valve (not provided)
- 3.3 Installation check points
 - 3.3.1 Water tank position
 - 3.3.2 Pipeline connection
 - 3.3.3 Condensate drain hose
 - 3.3.4 PTR valve and drain line must comply with local regulations
 - 3.3.5 Electrical connection
 - 3.3.6 Check the wire controller
 - 3.3.7 Confirm whether there is a problem with the machine settings
- 3.4 Heat pump start-up

4. Controller instructions

4.1 Safety warning

4.2 Operating instructions

4.2.1 Start-up & Shutdown operation

4.2.2 Temperature setting

4.2.3 Working mode setting

4.2.4 Time setting

4.2.5 Timing setting

4.2.6 Manual forced defrosting

4.2.7 WiFi function instruction

5. Inspection and maintenance

5.1 Inspection and maintenance precautions

5.2 Inspection items

5.2.1 PTR valve

5.2.2 Water tank flushing

5.2.3 Water tank emptying

5.3 Holiday and long-time shutdown

5.4 Cleaning of condensate drain pipe

5.5 Refrigerating circuit

5.6 Magnesium anode rod maintenance

5.7 Check/Replacement of magnesium anode rod

6. Fault code display

1. Product information

1.1 Product features

Easy to operate

The equipment adopts the user-friendly control panel with WiFi function, which is easy for users to operate.

Energy saving and environmental protection

The equipment heats water by absorbing energy from the surrounding air and releasing it into the water stored in the tank, so it is very energy efficient. If the ambient temperature is low, the heating capacity of the heat pump will decrease, and then the auxiliary electric heater can be used as a backup.

Overheating protection

The water tank is equipped with a thermostat protection device located above the electric heater and it is in contact with the inner tank surface. If the water temperature reaches preset temperature or there is no water in the tank due to any cause, the thermostat will automatically cut off the power circuit of the electric heater.

When the water temperature is higher than 90 °C, the manual protection device of thermostat will cut off the power supply. If the temperature returns to the normal level later, the thermostat needs to be turned on by manual reset.



Warnings

The cause of abnormal high water temperature must be investigated by a qualified service technician and corrective measures must be taken before the water heater is restarted.

Automatic defrosting

In the operating state of heat pump, the equipment will automatically defrost to ensure thermal efficiency.

Water temperature or pressure protection



For your safety, the equipment is equipped with a PTR valve. If the tank pressure reaches 850 kPa or the temperature reaches 90°C, the valve will automatically open to allow the pressure or temperature to drop to a safe value.



Water supply pressure

The water heater is designed to be directly connected to the water system. When the water supply pressure exceeds 800 kPa, a pressure reducing valve must be installed. The minimum water supply pressure of 200 kPa is required to ensure the normal water supply of the water heater.

If the PTR valve or other safety devices has been tampered or not been installed in accordance with the instructions in this manual, the company will not be responsible for the consequences.

1.2 Technical Nameplate:

	025 200	EH
Model: Elix hybrid GM200		
0.4 kW, 200 I, 0.8 MPa, 240 V~, 50/60 Hz		
№ XXXXXXXXXXXXXXXXXXXX		
WARNING! Water heater MUST be grounded and safety valve must be properly fitted!		
Made in PRC		IPX4

	025 300	EH
Model: Elix hybrid GM300		
0.4 kW, 300 I, 0.8 MPa, 240 V~, 50/60 Hz		
№ XXXXXXXXXXXXXXXXXXXX		
WARNING! Water heater MUST be grounded and safety valve must be properly fitted!		
Made in PRC		IPX4

1.3 Circuit Diagram:

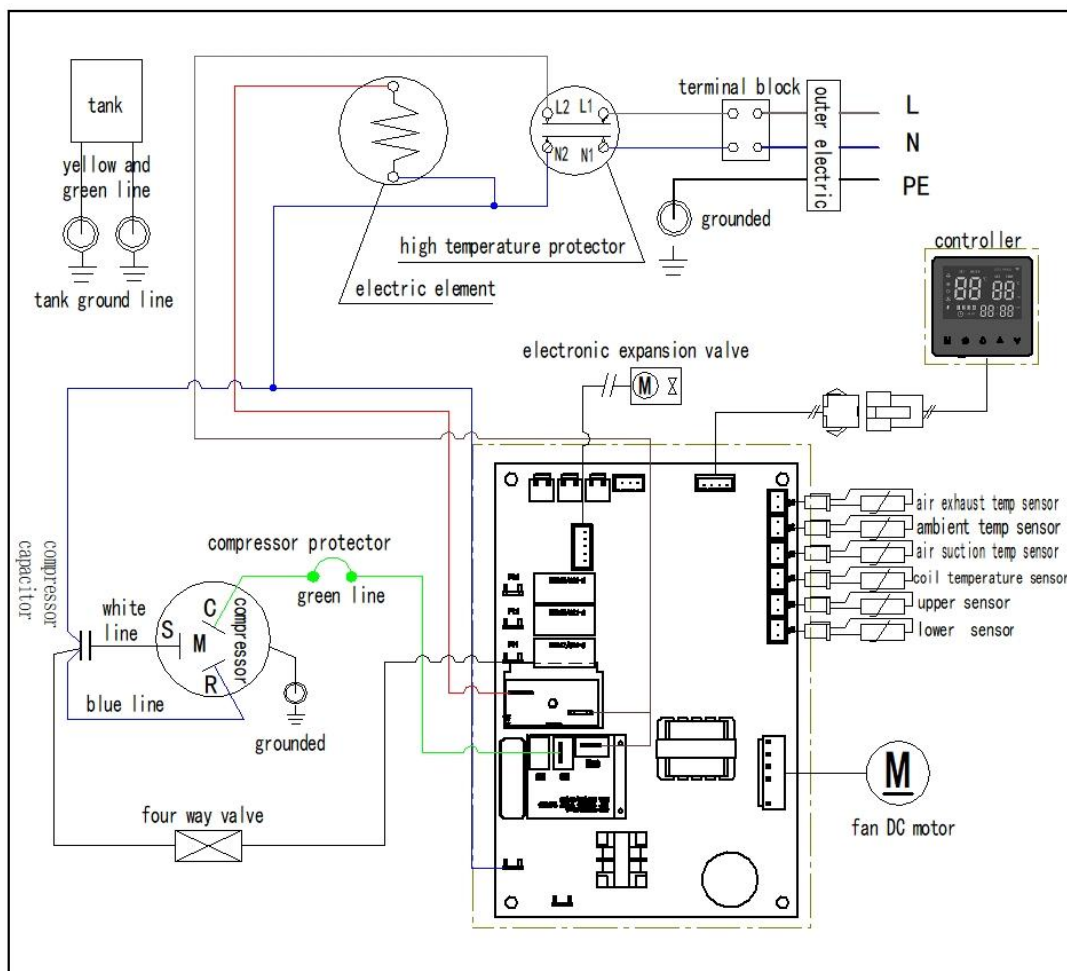

1.4 Working mode

- **Eco Mode:**

Only heat pump works, The water can be heated up to 60°C at maximum

- **Hybrid Mode:**

Both heat pump and electric element work together, The water can be heated up to 75°C at maximum

Note: The default hot water outlet temperature is 60°C.

1.5 Product appearance

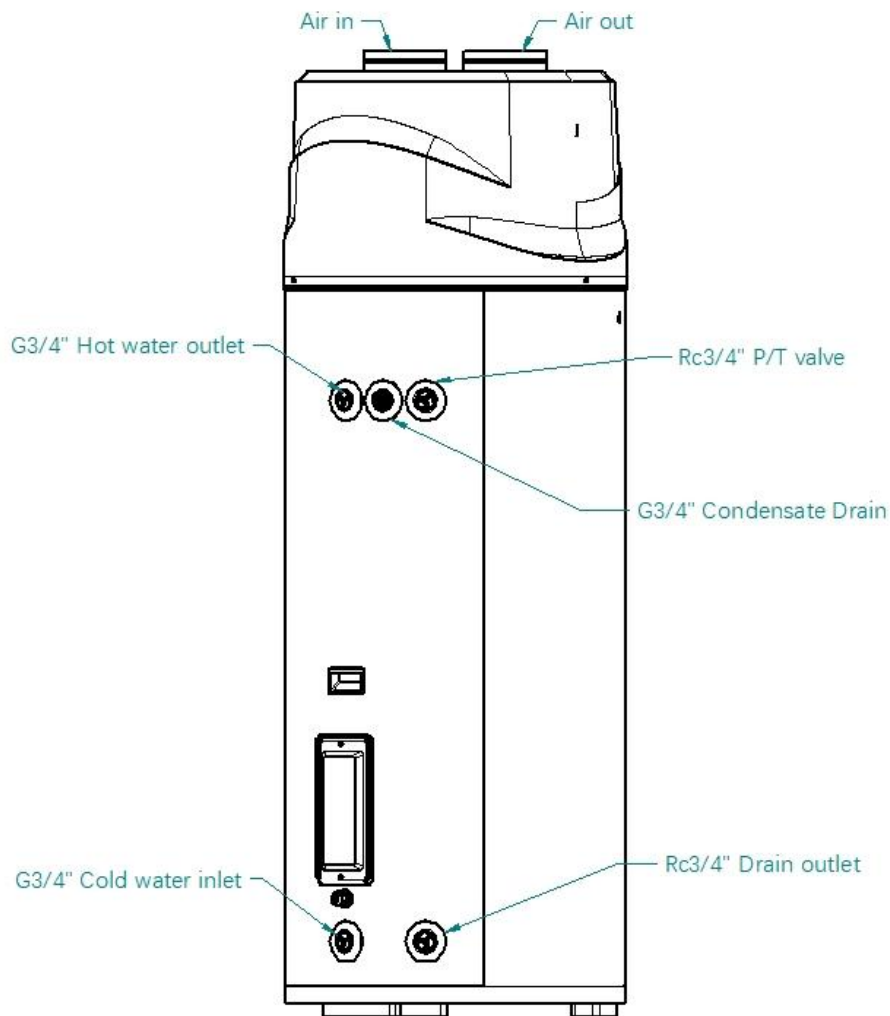

2. Storage, handling, transportation and installation

2.1 Storage and transportation

As a rule, the equipment should be packed erectly and the water tank be stored or transported as an empty water tank. For short-distance transport, care should be taken to allow a tilt angle of 30° at maximum. Whether transported or stored, the ambient temperature should be in the range of -20 °C~+60°C.

2.2 Handling

When handled and transported by a forklift, the equipment must be fixed to the pallet at all times. The lifting rate should be kept at the lowest limit. Due to the top-heavy weight, anti-overturn measures must be taken. To prevent any damage, the equipment must be placed on a level surface!

For handling, it must be noted that the maximum allowable tilt angle cannot exceed 15°. If tilting cannot be avoided during handling and transportation, the equipment can only be operated one hour after being moved to the final vertical position.



Warnings

Damage during transportation!

- ✧ **Avoid tilting the device over 15°.**
- ✧ **Be careful when handling equipment.**
- ✧ **To avoid dropping the equipment and damaging internal components, do not turn the equipment.**
- ✧ **To avoid equipment damage, the protective packaging shall be removed after the equipment has been transported to the installation site.**
- ✧ **Use straps to prevent the equipment from being scratched.**
- ✧ **Use the appropriate means of transportation to transport the equipment to the installation site (special vehicle, pallet truck, etc.)**

3. Installation

The manufacturer's warranty does not cover any damage caused by improper installation, connection or use of any type of accessory (except as listed in this user manual) of this water heater.

The use of unauthorized devices may shorten the life of the water heater and may result in death and property damage. The manufacturer is not responsible for any loss or damage caused by the use of such unauthorized devices.

3.1 Placement space requirements

Installation space requirements: to avoid affecting airflow, please ensure the equipment space requirements as shown.

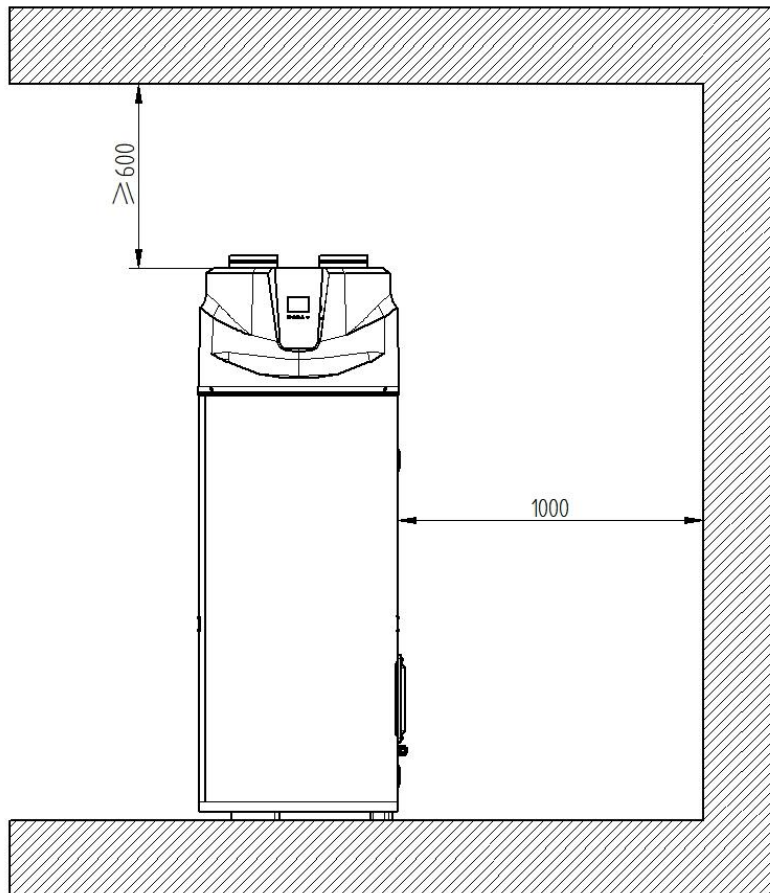
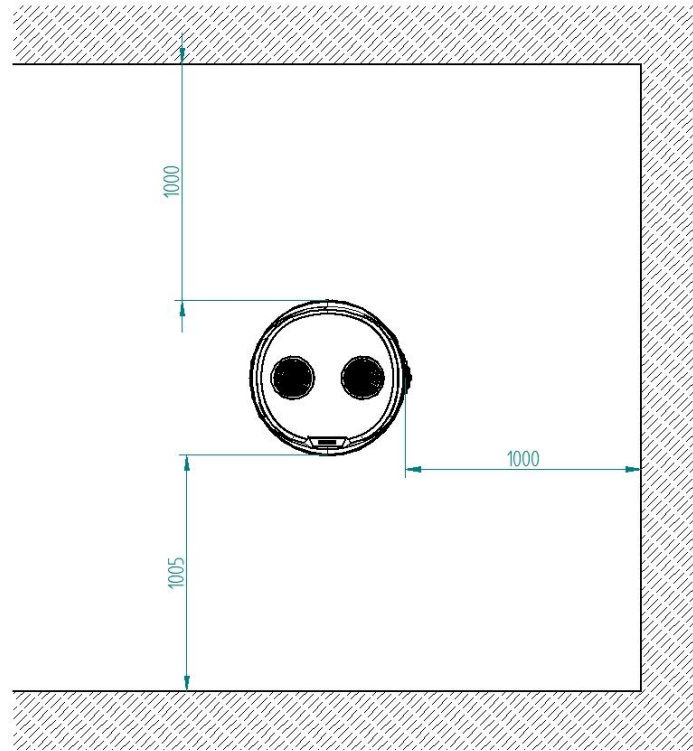



Warning

PTR valve coming with the equipment must be installed and the valve outlet must not be blocked, as this may be dangerous.

3.1.1 Installation location and space requirements

The water heater shall be installed in a clean place that is as close as possible to the area with the maximum hot water demand. The long non-insulated hot water pipes will waste energy and water.

When the water heater is placed, the space that is used for proper maintenance must be reserved, that is, the space required for removing the top cover, accessing to the PTR valve, and removing & installing the anode rod.

The entire equipment may be disassembled for future maintenance, so the water heater and water pipelines should be protected to prevent damage caused by severe cold and corrosive environments.

In the place where the water heater is installed, there must be sufficient drainage facilities, such as floor drains, to drain the water in the tank when the tank is repaired or cleaned.



Warning

The water heater should not be installed in areas with corrosive atmospheres (such as the areas for storing chemicals and flammable liquids, or releasing aerosols). When using this equipment, these corrosive, flammable vapors may be brought out from the storage area due to convection of air in the room or other confined space. Any arc that may be generated at the electrically controlled live part of the water heater may ignite these vapors, thus causing an explosion or fire that could result in severe burns or even death and property damage.

Suggestions

Even if the equipment is running at a low level of noise, it is best to install it away from the bedroom or other resting place.

Condensate discharge

The condensate produced by the water heater needs to be discharged, so there must be a drainage device close to the water heater.

3.1.2 Electrical requirements

Power requirements

The power cord parameters are: 3 X 2.5mm² or above.

This water heater must be directly connected to the main power supply of 220V-240V~ / 50Hz.



Warning

All electrical installation and wiring must be performed by qualified personnel in accordance with the wiring rules required by local authorities.

The water heater needs to be connected to the user's power supply line through the earth leakage protective device. It must be noted that the user's power supply line must have a grounding wire.

The earth leakage protective device is not waterproof, and it should pay attention to preventing water flowing in when used.

Correct grounding connection is essential. The presence of water in pipes and water heater can not provide sufficient grounding conductivity. Non-metallic pipes, dielectrics, flexible connections, etc. may cause the water heater to be electrically isolated.

The electrical components and insulation tests in the water heater must be performed between the live wire and ground wire, as well as the null line and the ground wire. The test between the live wire and the null line will destroy the electronic components.

3.2 Installation method

3.2.1 Water pipe connection



Warning

All piping work must be performed by qualified personnel in accordance with the requirements of local laws and regulations.

Care must be taken not to touch the pipelines as the temperature may be very high.

The supplied PTR valve must be installed, otherwise damage to the equipment or other property loss may be caused.

Installation of the inlet and outlet water pipelines: the inlet and outlet water threads are G3/4 (female thread). Pipelines must be high temperature-resistant, durable and weathering-resistant (outdoor installation).

Installation of PTR valve pipeline: The thread specification of the valve is G3/4 (male thread).

All pipelines should be insulated with suitable thermal insulation materials (if exposed, they must be weathering and UV-resistant) to optimize energy efficiency.

It is vitally important to scrupulously clean the pipeline before installing the pressure reduction valve, to prevent any small element or impurity from altering its correct operation. It is also highly recommended to

install a filter at pressure reduction valve inlet for protection. This should be installed in a horizontal pipe; the direction of flow must correspond to the direction shown by the arrow on pressure reduction valve body. After installation, test the water pressure, and adjust the regulator, if necessary. To adjust, loosen the locknut on the adjustment screw, then turn the screw up or down until the water pressure is at the desired level, as measured by a pressure gauge attached to a threaded hose bib somewhere in the home.



Warning

- ✧ **First inject cold water into the tank before the commissioning of the equipment.**
- ✧ **Open the water outlet connection and one or more hot water taps.**
- ✧ **Open the cold water inlet of the storage tank, start injecting water into the water tank.**
- ✧ **Turn off the hot water tap when there are no air bubbles in the water stream.**
- ✧ **Connect the equipment to the power supply via the power cord.**

Water quality requirements

Poor water quality will lead to a shortened product life. The magnesium rod shall be checked more frequently and replace it if necessary.

3.2.2 Condensate drain pipe

This water heater has an integrated condensate water pan. The water collected in the water pan is drained from the drain hole at the back of the water heater and its connected hose.

- ✧ Connect one end of the condensate drain pipe to the drain hole on the back of the water heater.
- ✧ The other end is directly connected to the floor drain.

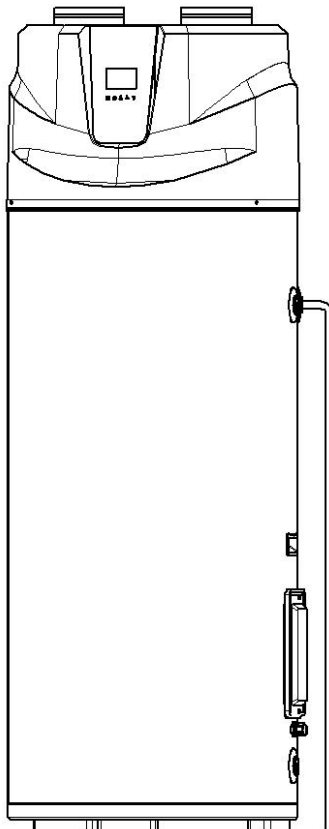

3.2.3 PTR valve installation

The PTR valve must be installed at the connection port marked “PTR valve” on the water heater. No other valve body or any other type of part should be installed between the PTR valve and the water tank. Please install the PTR valve correctly according to this valve's instruction manual.



Warning

The pressure rating of the PTR valve must not exceed 800 kPa.

The pressure relief device of the PTR valve shall be operated at least ONCE EVERY SIX MONTHS. When the operating lever is running, if the water cannot be discharged smoothly, the authorized relevant technician shall inspect the PTR valve or replace the PTR valve if necessary.

The PTR valve and its drain pipe must not be sealed or blocked. When heating the water, a small amount of water is allowed to leak from the PTR valve.

Once the PTR valve is installed on the water heater, its function is to discharge high temperature hot water under certain conditions. Therefore, it is highly recommended that the pipeline that connects the PTR valve can withstand temperatures higher than 99 °C. Failure to follow this advice can lead to dangerous situations.

Never block or seal the PTR valve or its drain outlet for any reason. If the PTR valve is changed arbitrarily or not installed in accordance with the instruction manual, the warranty will be invalid. It is recommended to connect a hose from the PTR valve outlet to the floor drain or a suitable drain device so that the drained water will not touch any electrical part, person or animal, thus eliminating any other possible risks.

In order to reduce the risk of excessive pressure or temperature in the water tank of the water heater, a PTR valve is required to be installed as the protection device as per the local laws and regulations.

3.2.4 Thermal expansion tank (not provided)

Thermal expansion is a natural process in which the volume of water is increased after it is heated. When the volume increase of the water stored in the water tank is limited, it will cause an increase in pressure. Increased pressure can lead to dangerous situations. If the safety settings on the PTR valve are already in place, the valve will act during the heating cycle. Generally, if the pressure in the tank reaches the nominal value of the valve, the excessive expansion may cause the valve to malfunction prematurely and accelerate the actuating force of the valve.

Therefore, it is recommended to install an expansion water tank to alleviate this kind of excessive pressure and avoid repetitive PTR valve action.

For more information on this issue, please consult the relevant professional or water heater supplier.

3.2.5 Temperature limiting device (not provided)



Warning

The water heater can heat the water to a temperature that may lead to scalds.

It is recommended to install a temperature limiting device at the water heater and hot water outlet in the bathroom or similar location to reduce the risk of scalds.

3.2.6 Pressure limiting valve (not provided)

If the tap water supply pressure exceeds the product's pressure rating 800kPa, a pressure limiting valve is required to be installed at the water inlet pipeline.

If the tap water supply pressure is lower than the product's pressure rating 200kPa, a pressure increasing valve is required to be installed at the water inlet pipeline to provide the necessary pressure or reduce the generation of bubbles in the water system.

3.3 Installation check points

3.3.1 Water tank position

- ✧ The front and back of the water heater should be unobstructed and clean.
- ✧ The bottom of the water heater must be flat, otherwise spacers need to be added.

3.3.2 Pipeline connection

Inject tap water into the water tank after the water pipes are connected and check if there is water leak at each joint.

3.3.3 Condensate drain hose

The condensate drain hose should be connected to the drain hole of the water pan and the floor drain, drain device or drain pump.

3.3.4 PTR valve and drain line must comply with local regulations

3.3.5 Electrical connection

- ✧ Electrical connections shall not obstruct the removal of the inlet and outlet air grids.
- ✧ All electrical connections require insulating treatment.

3.3.6 Check the wire controller

- ✧ Verify whether each operation button on the control panel is flexible and displays normally
- ✧ Check whether the mode, temperature, time, and other function settings are correct. The default temperature is set to be 60 °C

3.3.7 Confirm whether there is a problem with the machine settings

Start up the water heater after confirming that there is no problem with the settings. Please pay attention to protecting the control panel.



Warning

The power supply cannot be activated before the water tank is filled with water.

3.4 Heat pump start-up

After the water heater is installed and all electrical and water connections are also determined and checked, it should be filled with water (the water tank is ensured to be filled with water by opening the hot water tap at somewhere in the home for drawing off water). Once the tank is filled with water and powered, the user must press the power button on the wire controller to start the equipment. The startup process is as follows.

Time	Heat Pump	Notes
0---110 seconds	The water heater is with no action	Prevent compressor from damage.
110---170 seconds	Solenoid valve opens	
170---180 seconds	Fan starts	
180 seconds later	Compressor starts	High-efficient heat pump heating.

The ambient temperature range for heat pump operation is $-5\text{ }^{\circ}\text{C} \sim 43\text{ }^{\circ}\text{C}$. If the ambient temperature is outside this range, the heat pump will not operate and the auxiliary electric heater will start to heat the water instead of the heat pump. It will return to the heat pump mode when the ambient temperature restores to the operating temperature range of the heat pump.

4. Controller instructions

4.1 Safety warning



Warning

Do not turn on the water heater if the cold water supply switch is off.

Turn off the power if the water heater is overheated or subject to fire, flood or other physical damage.

The installation, commissioning, maintenance and cleaning of the water heater must be completed by professional technicians or maintenance personnel.

4.2 Operating instructions

Control panel



4.2.1 Start-up & Shutdown operation

- Power on: press “

4.2.2 Temperature setting

- Press “

4.2.3 Working mode setting

- Press “

Note: It will switch to ECO mode automatically after RPAJD mode is finished.





4.2.4 Time setting

- Press “



4.2.5 Timer setting

- Press “

15

- Timing 2: press “” to come into timing 2, and operation is as the same as timing 1 ;
- Press “”, then press “” and “” to select timing 1 or timing 2, then press “” to cancel timer setting.

4.2.6 Manual forced defrosting

- Press “” and “” for over 5 seconds , then the defrosting is forced to start, and the maximum defrosting time is reached or the protection fault exits.

4.2.7 WiFi function instruction

• Download and Install the App

1) Scan the QR code to download the "Smart Life" application, or download the application in the application store by mobile phone, and then install the application. (available for Android and iOS system)

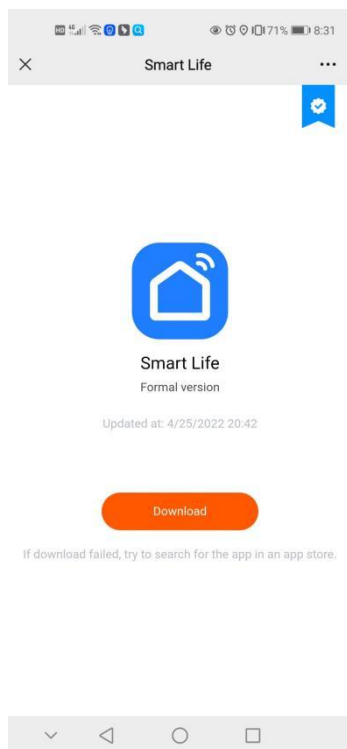

2) Sign up

After installing the app, press the "  " icon and open the Smart Life app, if there is no account, should sign up at first time, refer to following process:

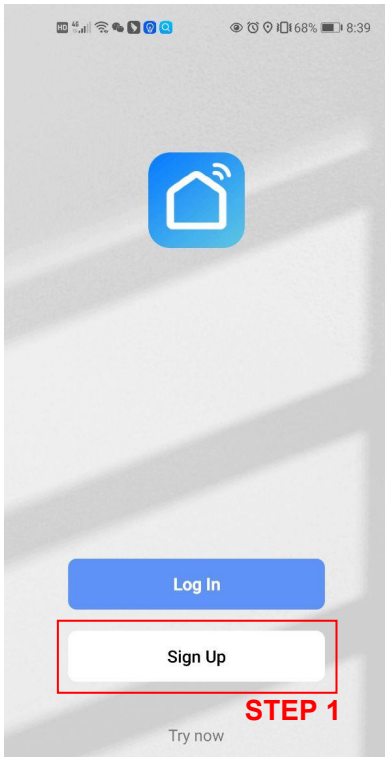

STEP 1

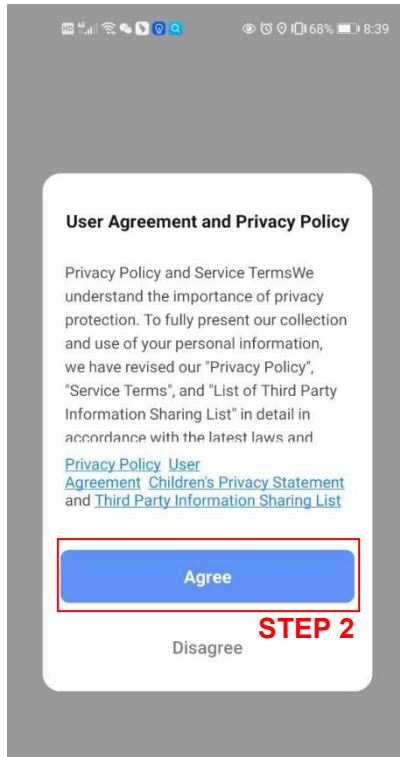

STEP 2

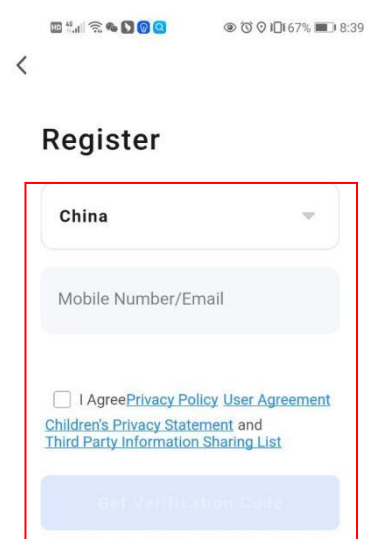

STEP 3

**select country, input mobile number
select I Agree then get the
verification code**

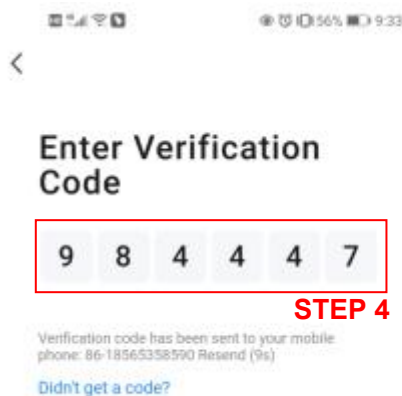

STEP 4

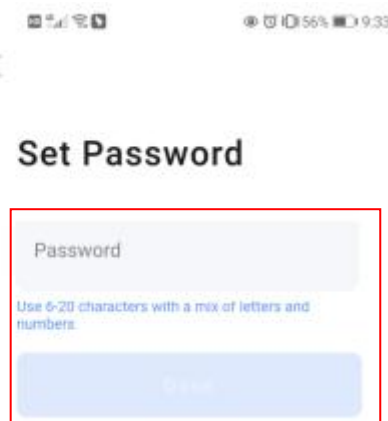

STEP 5

3) Log in

After signing up, log in the application refer to following process:

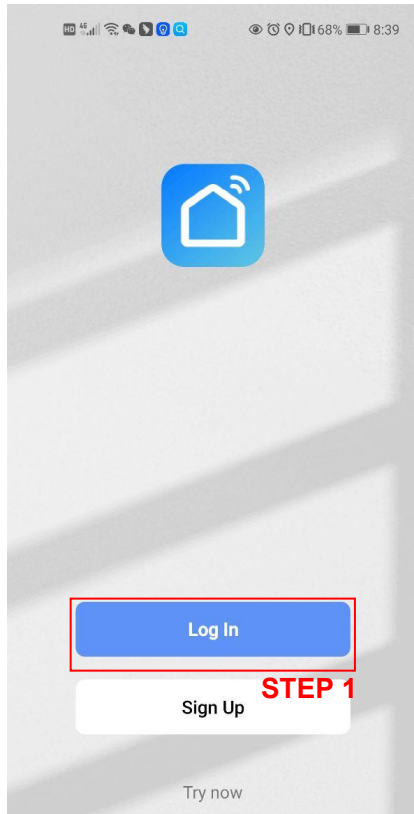

STEP 1

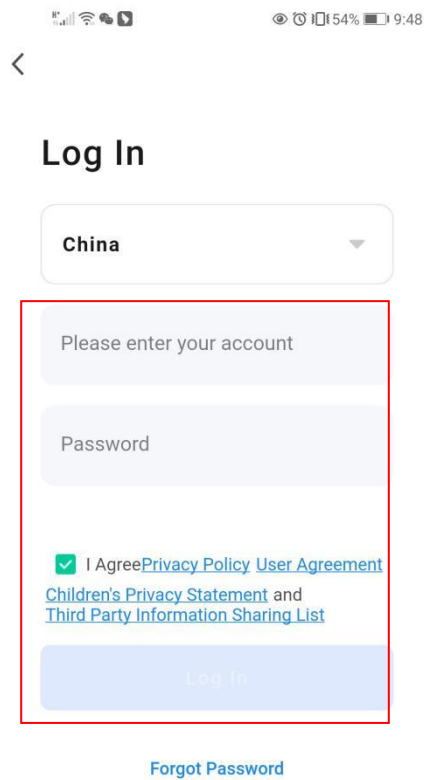

STEP 2
Input account and password
and log in



4) Create home

After signing up, should create " home ", refer to following process:

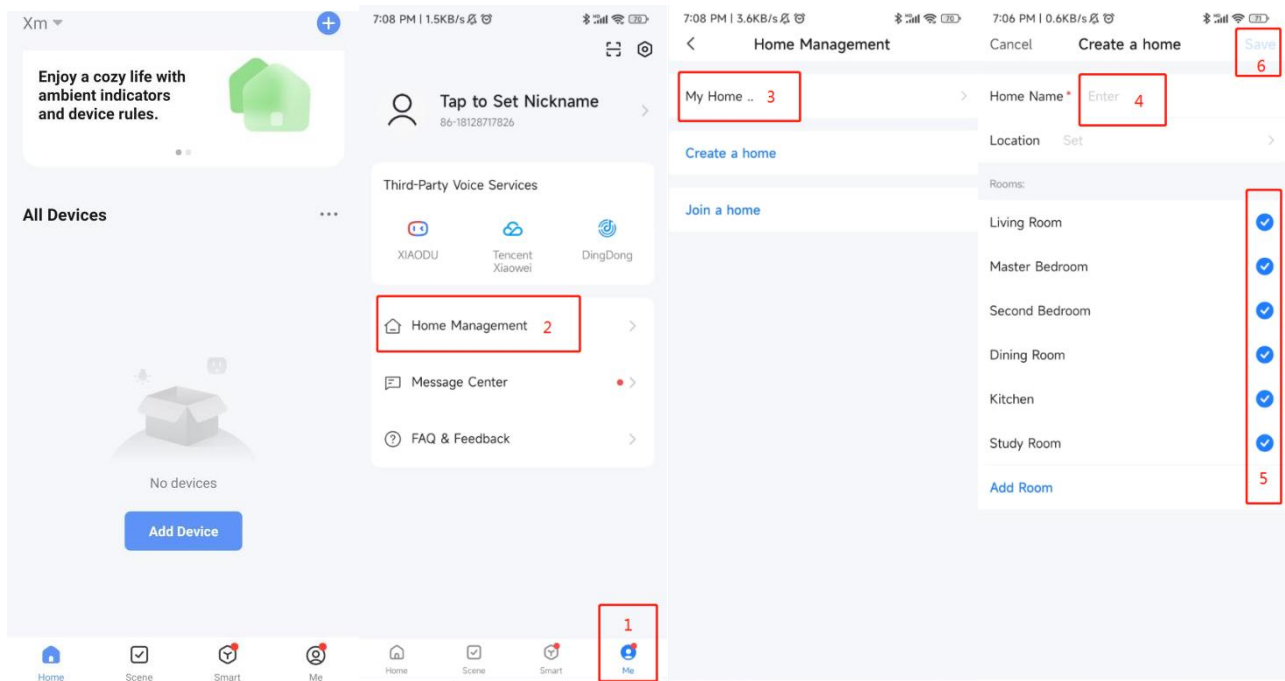
Home Management → Set home name → Set location → Add room → Save



● **Connect the WIFI**

1) Press and hold the two keys  and  for 5s, enter into manual intelligent distribution network connection, within 3 minutes, wait for connecting, the symbol "  " will flash, after three minutes, exit connecting automatically if failed in connecting.



2) Use mobile phone connect the WIFI hot spot, the hot spot should be available for internet.



3) Open the app Smart Life and log in, press the icon " + ", or press " Add Device " → find " Large Home Appliance " → select the " Smart Heat Pump (Wi-Fi) " → enter into WIFI connecting interface, input the WIFI password (the WIFI account must be same as the WIFI which mobile phone connected), → press " next " → press the " Confirm the indicator is blinking... " → select the " Blink Quickly" → Wait for finding device, until the device appeared → press " + " to add the device, and give a new name of this device if need → finish adding device, shows the operation interface.

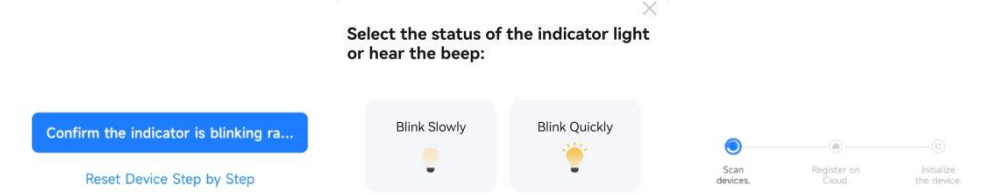
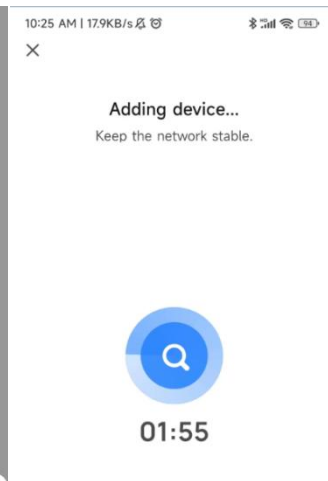
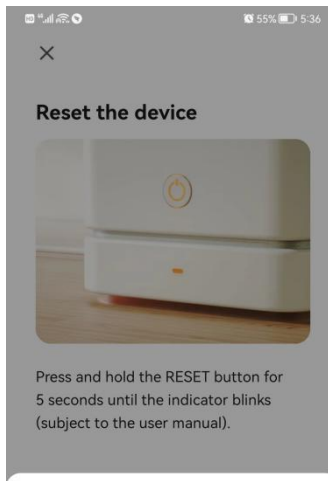
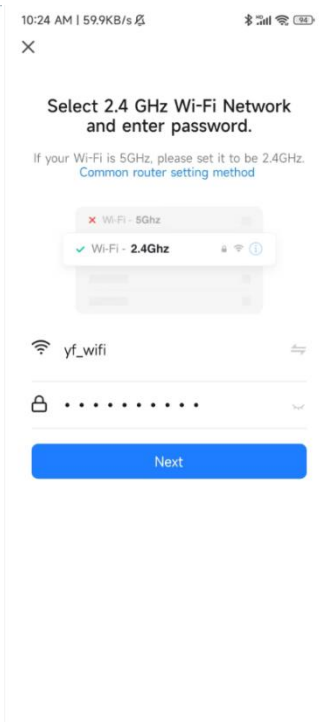
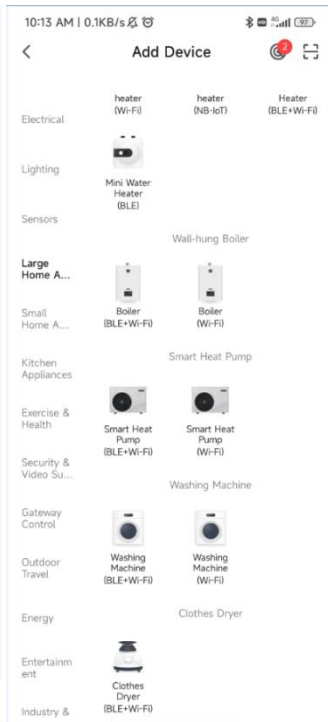
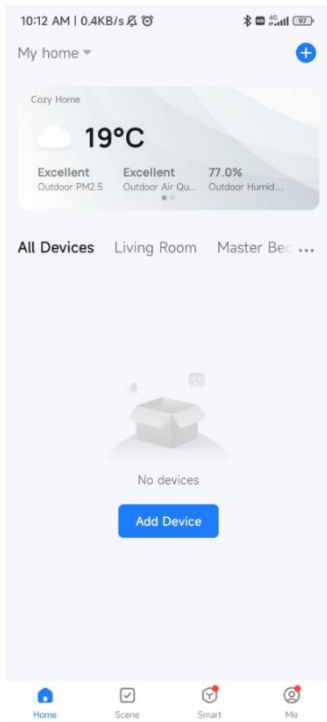

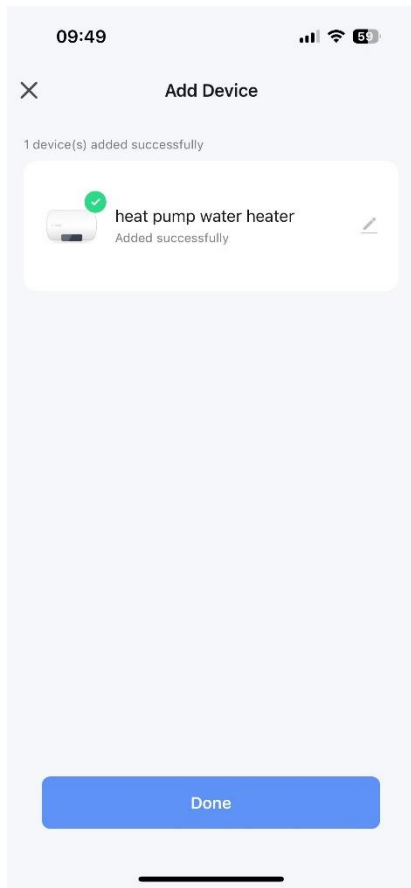

● Operation

1) Set water temperature



Move the circle to change the water temp setting



2) Mode change



Press this key to
choose working
mode you want



3) Set timer

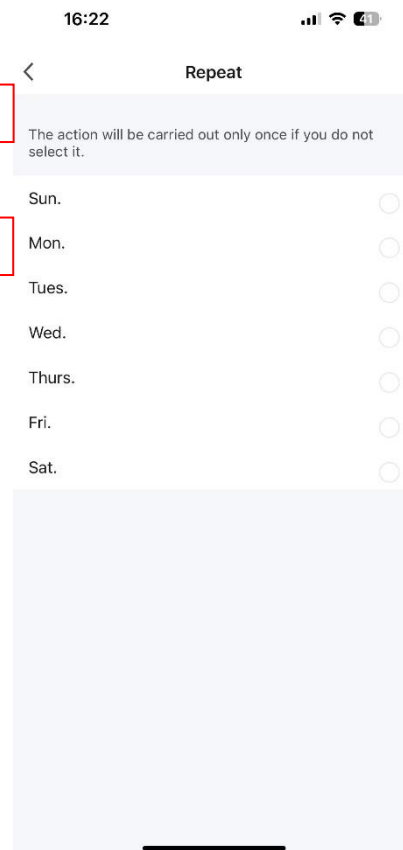
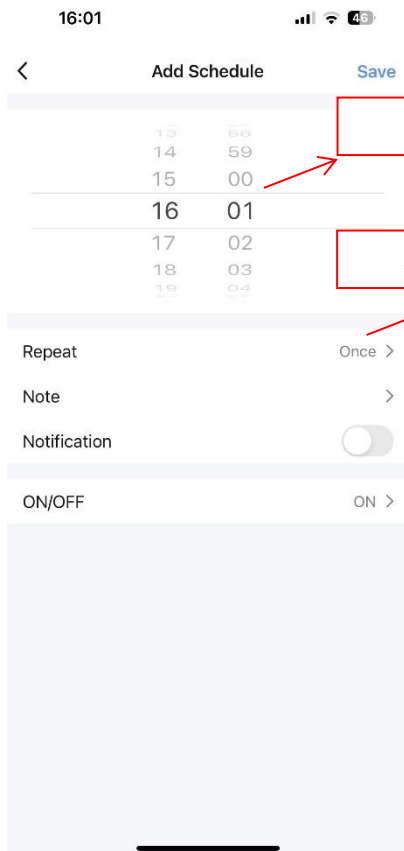
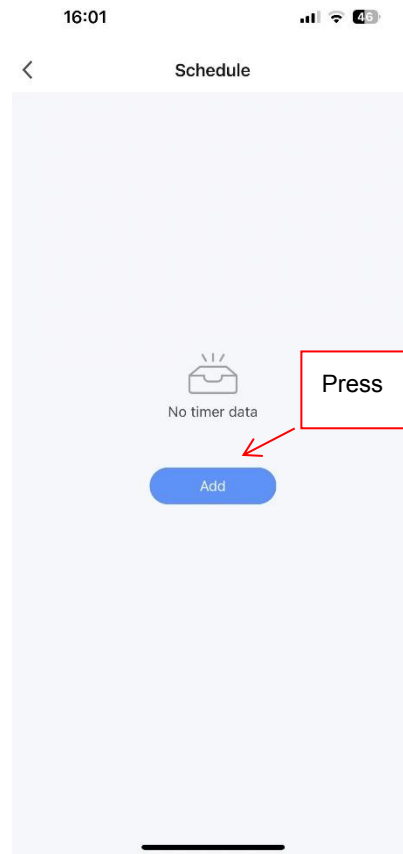

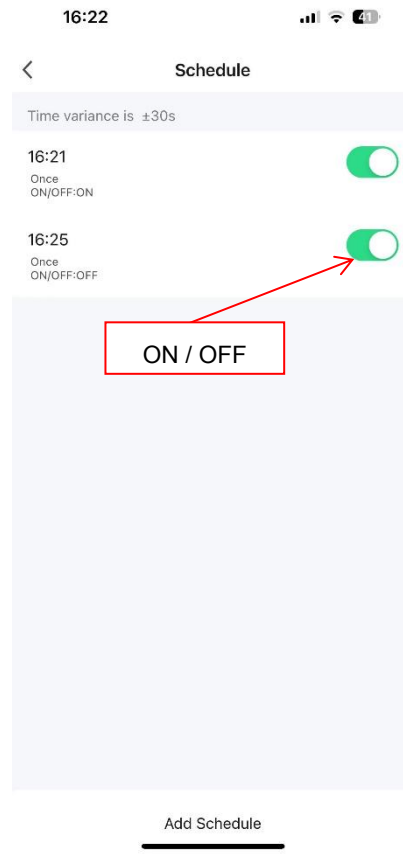
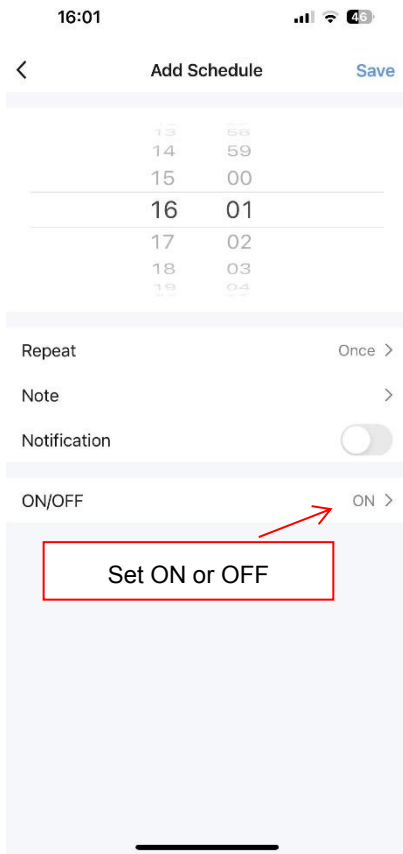

5. Inspection and maintenance



Warning

The water heater should be repaired and maintained by professionals in accordance with local plumbing standards.

Before manually operating the PTR valve, make sure that no one will be exposed to danger because of contacting the hot water released by the valve. The water may not heat up to the level of scald, however it is still necessary to use a suitable drain pipe to release the water to avoid possible injury or property damage.

Periodic release of the PTR valve is part of normal operation. This is because there is thermal expansion in a closed water system that causes an increase in pressure. If such release becomes excessively frequent and continuous, please contact the after-sales service provider and don't block the outlet of the valve.

Note: Proper maintenance of the water heater will provide a longer, reliable, trouble-free and economical operating life.

It is recommended to establish a regular preventive maintenance program for the users to follow up.

5.1 Inspection and maintenance precautions

It is recommended that periodic inspections of the controller, heating elements, and wiring should be performed by qualified electrical service personnel.

It is recommended that the evaporator and refrigeration circuit be inspected and cleaned every 5 years for dust and residue. In dusty environments, they should be inspected and cleaned more frequently.

5.2 Inspection items

5.2.1 PTR valve

The lever handle of the valve should be lifted and released at least once every 6 months to ensure flexible operation of the valve.

A few liters of water shall be allowed to drain from the valve so as to flush the valve body, but the drained water should be connected to an external drain pipe to flow to the floor drain.

It is strictly forbidden to replace the existing PTR valve with a PTR valve that is higher than the pressure rating specified by the water heater.

If the valve body cannot drain water when the release lever is opened or it cannot be well sealed when the release lever is closed, it must be promptly replaced by a professional.

The PTR valve can not be repaired.



Warning

Before manually operating the PTR valve, make sure that no one is exposed to the hot water released by the valve body. The hot water discharged from the water tank may not be sufficient to cause scalds, but should be connected directly to an appropriate drain place to prevent injury or damage.

5.2.2 Water tank flushing

The suspended solids in water are easily deposited at the bottom of the tank. Therefore, it is normal to have hard water sediments at the bottom of the tank.

It is recommended to periodically drain the water and then inject water into the water tank to wash the sediments at the bottom of the tank every 6 months.

5.2.3 Water tank emptying



Warning

Please turn off the power of the water heater before draining the water.

Risk of scalds!

Please check the hot water temperature of the water heater before opening the PTR valve. Until the water temperature drops to a level that is insufficient to cause scalds or other injuries.

Discharge water from the drain outlet, where a large amount of water will be drained. To ensure proper drainage, the following points need to be noted:

- ✧ Close all hot water taps.
- ✧ Isolate cold water supply.
- ✧ Remove the cold water inlet connection until the drain is stopped.
- ✧ Open a hot water tap.
- ✧ Wait until all the water is drained.

5.3 Holiday and long-time shutdown

If the water heater will be kept idle for a long period of time, in order to save energy, the power and water supply of the equipment should be turned off.

Although the water heater has an antifreeze function, if the water heater and pipeline may be subjected to freezing temperatures, both of them should be drained. After a long period of shutdown, the operation and control of the water heater should be checked by qualified maintenance personnel. Make sure the

water heater is completely filled with water before running the water heater.

5.4 Cleaning of condensate drain pipe

The condensate drain outlet is located on the back of the water heater. If it is clogged, water will overflow from the outside of the water heater, so it is necessary to regularly clean and clear the condensate drain outlet.

- ✧ Remove the condensate drain pipe.
- ✧ Clear and unblock the debris and attachments from the drain outlet.
- ✧ Periodically inspect the drain pipe and remove any debris that may gather in the drain pipe.

5.5 Refrigerating circuit



Warning

Repairs to the refrigeration system circuits (e.g compressors, tank coils, evaporators, thermal expansion and solenoid valves, etc.) can only be carried out by authorized after-sales service providers.

5.6 Magnesium anode rod maintenance

The magnesium anode rod of water heater is the most important protective part against corrosion and premature failure for any water tank.

Therefore, it is very important to check the magnesium anode rod. It is generally recommended by the water heater industry to check the anode rod once a year.

Apartments that supply salty or softened water should consider being inspected more frequently. If there is any doubt, please consult your local plumbing expert.

If necessary, please contact an authorized person to inspect and replace the magnesium anode rod.

5.7 Check/Replacement of magnesium anode rod

The tank of the water heater shall be protected against corrosion by an internal magnesium anode rod.



Warning

Damage caused by the water heater operation without the protection of magnesium anode rod is not covered by our warranty.

It needs to check the magnesium anode rod every year and replace the magnesium anode rod if necessary.

The inner wall of the water storage tank is coated with an enamel coating, which is only used for the corrosion protection of normal water quality. When more corrosive water is used, the protection can only be effective if additional safety measure (anode rod) is taken and the magnesium rod is checked more frequently.

Check the protective magnesium anode rod:

- ✧ Disconnect the water heater from the power supply.
- ✧ Turn off the water supply.
- ✧ Remove the magnesium anode rod.
- ✧ Perform a visual inspection and replace it if necessary.
- ✧ It is recommended to replace the anode magnesium rod at least every 2 years.

6. Fault code display

Installation, maintenance and repairs can only be carried out by an authorized service supplier. The fault codes and handling measures are listed in the following table:

Error Code	Error Contents	Solution
P01	Lower Water tank sensor failure	Secure the connector or replace the sensor
P02	Upper Water tank sensor failure	Secure the connector or replace the sensor
P03	Coil sensor failure	Secure the connector or replace the sensor
P04	Suction sensor failure	Secure the connector or replace the sensor
P05	Ambient sensor failure	Secure the connector or replace the sensor
P07	exhaust gas temperature failure	Secure the connector or replace the sensor
P07	High exhaust gas temperature protection	Check if the exhaust temperature exceeds the set value
E02	Low pressure protection	Check whether the refrigerant leaks
E08	Communication failure	Check communication line, line sequence, connector, type